



RoHS

LH25-10B37

----- is a compact size power converter offered by Mornsun. It features universal input voltage, taking both DC and AC input voltage, low power consumption, high efficiency, high reliability, safer isolation. It offers good EMC performance, and widely used in industrial, office and civil applications. For harsh EMC environment, this series of products must use the referred application circuit.

PRODUCT FEATURES

1. Universal Input :85 ~ 264VAC,50/60Hz
2. Regulated output, low ripple and noise
3. Efficiency up to 85%
4. Over-current, short circuit and over-temperature protection
5. Plastic case, meets UL94V-0

PART NUMBER SYSTEM

LH25-10B37

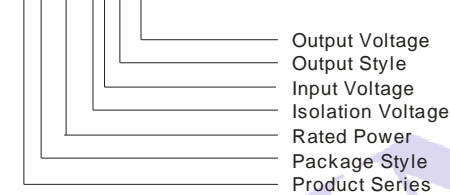

SELECTION GUIDE

Approval	Model	Package	Power	Output (Vo/Io)	Ripple and Noise(Typ)	Efficiency (%) (Typ.)
	LH25-10B37	70X48X23.5mm	25W	37V/670mA	50mV	85

INPUT SPECIFICATIONS

Input voltage range	85~264VAC, 120~370VDC		
Input frequency	47~63Hz		
Input current	110VAC 420mA, typ	230VAC 230mA, typ	
Inrush current	110VAC 16A, typ	230VAC 30A, typ	
Leakage current	0.3mA RMS typ./230VAC/50Hz		
Recommended External Input Fuse	3.15A/250V	Slow-Blow	

OUTPUT SPECIFICATIONS

Voltage set accuracy		±2%
Input variation		±0.5%
Load variation (10-100%)		±1%
Minimum load		0%
Ripple & noise(p-p)	20MHz Bandwidth	50mV (Typ) 100mV (Max)
Short circuit protection		Continuous, and auto resume
Over current protection		≥ 110% Io
Output over-voltage protection		≤ 43VDC

COMMON SPECIFICATIONS

Temperature specifications	Operating temperature	-40℃ ~ +70℃
	Power derating (55℃ ~ 70℃)	3.75% / °C
	(-40℃ ~ -10℃)	2% / °C
	Storage temperature	-40℃ ~ +105℃
	Case temperature	+90℃ max
Hold-up time	(Vin=230VAC)	80ms(typ)
Humidity		95%(max)
Temperature coefficient		0.02%/°C
Switching frequency		65kHz(typ.)

I/O-isolation voltage			3000VAC/1Min	
EMC	EMI	CE	CISPR22/EN55022, CLASS B(without external circuit)	
		RE	CISPR22/EN55022, CLASS B(without external circuit)	
	EMS	ESD	IEC/EN 61000-4-2 Contact ±6KV / Air ±8KV	perf. Criteria B
		RS	IEC/EN 61000-4-3 10V/m	perf. Criteria A
		EFT	IEC/EN 61000-4-4 ±2KV(without external circuit)	perf. Criteria B
			IEC/EN 61000-4-4 ±4KV (with typical applications Figure 3)	perf. Criteria B
		Surge	IEC/EN 61000-4-5 ±1KV/±2KV(without external circuit)	perf. Criteria B
IEC/EN 61000-4-5 ±2KV/±4KV (with typical applications Figure 3)	perf. Criteria B			
Safety standards			IEC60950,EN60950,UL60950	
Safety Class			CLASS I	
Case material			UL94V-0	
Install			PCB	
MTBF			>300,000H @25°C	
Weight			120g	
Note: 1. Ripple and Noise are measured by the method of parallel lines; 2. All specifications measured at Ta=25°C, humidity<75%, nominal input voltage and rated output load unless otherwise specified; 3. All characteristics are for listed model only, non-standard models may perform differently, please contact our technical person for more detail.				

PARALLEL LINES MEASURE

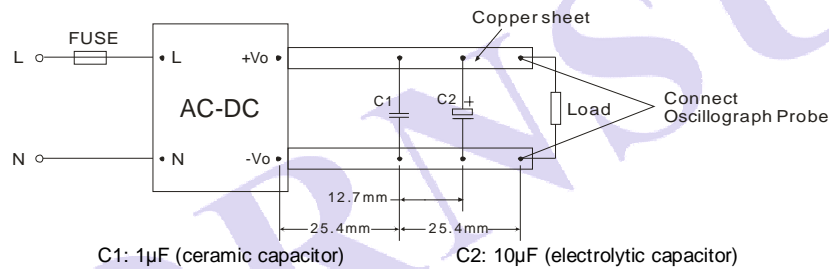

INPUT VOLTAGE VS LOAD TEMPERATURE VS LOAD

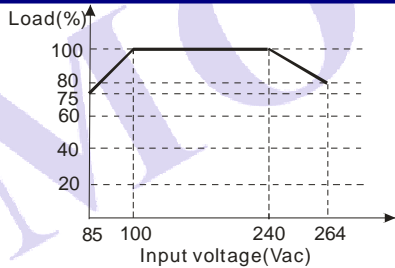

*Note: When input DC, $V_{dc}=1.414 \cdot V_{ac}-20$.

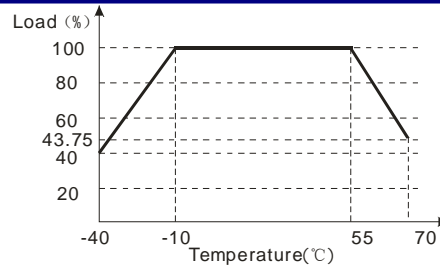

TRIM APPLICATION & TRIM CALCULATION

Application circuit for TRIM
(Part in broken line is the interior of models)

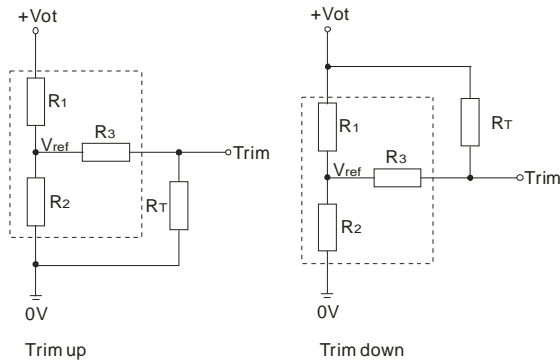

Formula for resistance of Trim

$$\text{up: } R_T = \frac{aR_2}{R_2 - a} - R_3 \quad a = \frac{V_{ref}}{V_{ot} - V_{ref}} \cdot R_1$$

$$\text{down: } R_T = \frac{aR_1}{R_1 - a} - R_3 \quad a = \frac{V_{ot} - V_{ref}}{V_{ref}} \cdot R_2$$

Note: Value for R1, R2, R3, and Vref refer to the following table.

R_T: Resistance of Trim

a: User-defined parameter, no actual meanings.

Vo(V)	37
Resistance	
R1(KΩ)	33
R2(KΩ)	2.4
R3(KΩ)	1
Vref(V)	2.5
Vot(V)	Output voltage of Trim, variation ≤ ±10%

TYPICAL APPLICATIONS

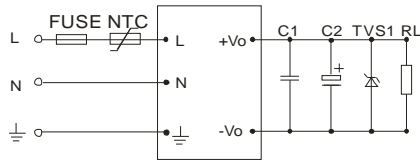

(Figure 1)

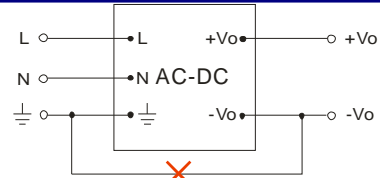

(Figure 2)

Note: This application is not supported for this series.

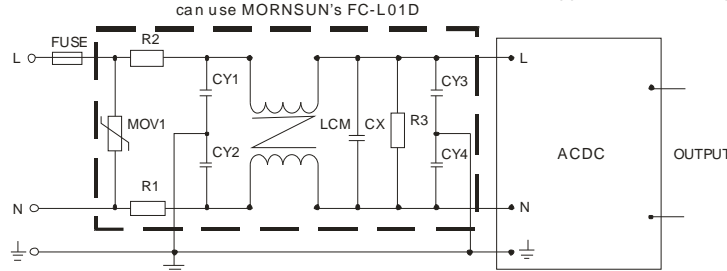

Figure 3: Recommended circuit for application require higher EMC standard (external circuit output same as above)

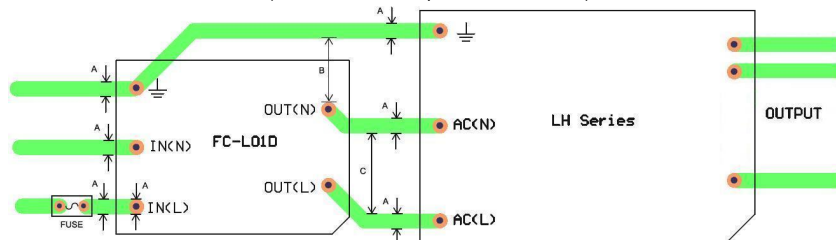

Figure 4: EMC application circuit PCB layout
Safety and recommend wiring: linewidth $A \geq 3\text{mm}$, $B \geq 6\text{mm}$, $C \geq 9\text{mm}$

EXTERNAL CAPACITORS TYPICAL VALUE(Unit: μF)

MODEL	C1	C2	NTC	TVS1
LH25-10B37	1	68	5D-9	SMBJ43A

Note:

- Output filtering capacitors C2 is electrolytic capacitors, It is recommended to use high frequency and low impedance electrolytic capacitors. For capacitance and current of capacitor please refer to manufacture's datasheet. Voltage derating of capacitor should be 80% or above. C1 is use to filter high frequency noise, suggest choose 1 μF . TVS is recommended component to protect post-circuits (if converter fails). External input NTC is recommended to use 5D-9.
- For standard EMC requirement, please refer to figure 1, if higher EMC requirement, please refer to figure 3.
MOV: Varistor, model: 561KD14, it is used to protect the device under surge;
R1、R2: 2 Ω /3W Winding resistor;
R3: 1M Ω /2W;
CY1、CY2、CY3、CY4: 102M/400VAC;
CX: 224K/275VAC;
LCM: 10mH-30mH;
FC-L01D: MORNSUN's 2KV/4KV Surge protector.
- FUSE: recommended to use 3.15A/250V.

OUTLINE DIMENSIONS & RECOMMENDED FOOTPRINT

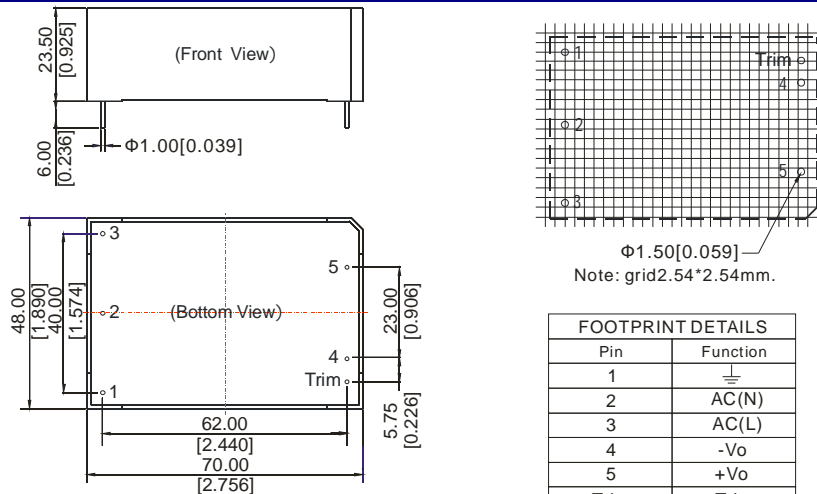

Note:
Unit:mm[inch]
Pin diameter tolerances: $\pm 0.10\text{mm}$ [$\pm 0.004\text{inch}$]
General tolerances: $\pm 0.50\text{mm}$ [$\pm 0.020\text{inch}$]

Pin	Function
1	GND
2	AC(N)
3	AC(L)
4	-Vo
5	+Vo
Trim	Trim

PACKAGE DIAGRAM



Inner packaging box dimensions: L*W*H=355*192*93mm
Packaging quantity: 20pcs
Outer packaging box dimensions: L*W*H=405*380*305mm
Packaging quantity: 120pcs

MORNSUN Science & Technology Co.,Ltd.

Address: No. 5, Kehui St. 1, Kehui development center, Science Ave., Guangzhou Science City, Luogang district, Guangzhou, P.R.China.

Tel: 86-20-38601850

Fax: 86-20-38601272

[Http://www.mornsun-power.com](http://www.mornsun-power.com)

MORNSUN